

### ZAWIAS TOCZONY Z KULKĄ

Weldable hinges with the ball  
Sustruzene panty s guľoučkou  
Závěs k přivaření s kuličkou  
ПЕТЛЯ ТОЧЕНАЯ С ШАРИКОМ

	WYMARY (mm)		PAKOWANIE (szt.)	WAGA (g)
ZTK12	A	B	10	43
	50	12		

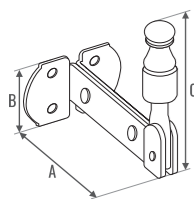

### PRZYTRZYMYWACZ DO FURTEK I OKIENNIC

Holder for gates and window shutters  
Držiak vrátok a okienic  
Zarážky pro branky a okennice  
ОГРАНИЧИТЕЛЬ ДЛЯ КАЛИТОК И СТАВНЕЙ



	WYMARY (mm)			KOLOR	PAKOWANIE (szt.)	WAGA (g)
PDF4B	A	B	C	ocynk żółty	1	138
PDF4C	85	35	75	lakierowanie	1	138

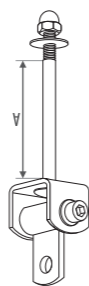

### MOCOWANIE HUŚTAWKI TYP „G”

SWING HANGER TYPE „G”  
UCHYTENIE HOJDACKY TYP „G”  
UCHYSEŇÍ HOUPAČKY TYP „G”  
КРЕПЛЕНИЕ ДЛЯ КАЧЕЛЕЙ ТИП „G”



	WYMARY (mm)	ŚRUBA (mm)	PAKOWANIE (szt.)	WAGA (g)
MHG120	A	M10	2	408
	120			

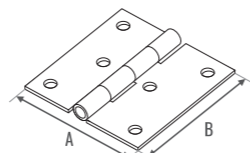

### ZAWIAS SPLATANY

Plait hinges  
Klavirove panty  
Závěs splétaný  
ШАРНИР ПЛЕТЕНЫЙ



	WYMARY (mm)		GRUBOŚĆ (mm)	PAKOWANIE (szt.)	WAGA (g)
ZS45	A	B	1.2	50/200	15
	45	45			

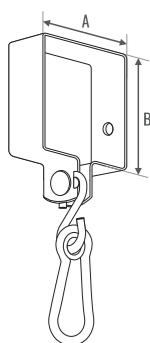

### MOCOWANIE HUŚTAWKI Z OBEJMĄ KWADRATOWĄ

Swing hanger with square clamp  
Uchytienie hojdacki so stvorcovou obimkou  
Uchycení houpačky se čtverc objímkou  
КРЕПЛЕНИЕ ДЛЯ КАЧЕЛЕЙ КВАДРАТНОЕ

	WYMARY (mm)		GRUBOŚĆ (mm)	PAKOWANIE (szt.)	WAGA (g)
MHK70	A	B	3.0	10	400
MHK100	70	70	2.5	10	500
MHK120	100	100	2.5	10	550

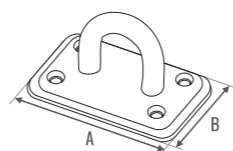

### ZACZEP WRZĘCIĄDZA BUDOWLANEGO

Catch of butt hasp  
Rigel stavebne zavory  
Úchyt kovového zámku, stavebného  
РУЧКА ЗАКРЫТИЕ СТРОИТЕЛЬНАЯ



	WYMARY (mm)		GRUBOŚĆ (mm)	PAKOWANIE (szt.)	WAGA (g)
ZWB3	A	B	1.5	20	79
	75	50			



ZPH  
**MARK**  
PROFESJONALNE ŁĄCZNIKI  
DO DREWNA

# NOWE PRODUKTY

# 2024

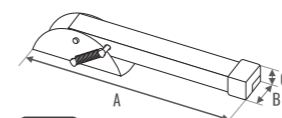

DOSTĘPNE KOLORY:



### PODPÓRKA DRZWIOWA KWADRAT

Square door support  
Námestie podpery dverí  
Náměstí podpěrka garážových dveří  
КВАДРАТ УПОР ДЛЯ ВОРОТ

	WYMARY (mm)			KOLOR	PAKOWANIE (szt.)	WAGA (g)
PDK200CZ	A	B	C	czarna	6	282
PDK200BR	200	30	20	brąz	6	282
PDK200AN	200	30	20	antracyt	6	282
PDK300CZ	300	30	20	czarna	6	346
PDK300BR	300	30	20	brąz	6	346
PDK300AN	300	30	20	antracyt	6	346
PDK470CZ	470	30	20	czarna	6	500
PDK470BR	470	30	20	brąz	6	500
PDK470AN	470	30	20	antracyt	6	500

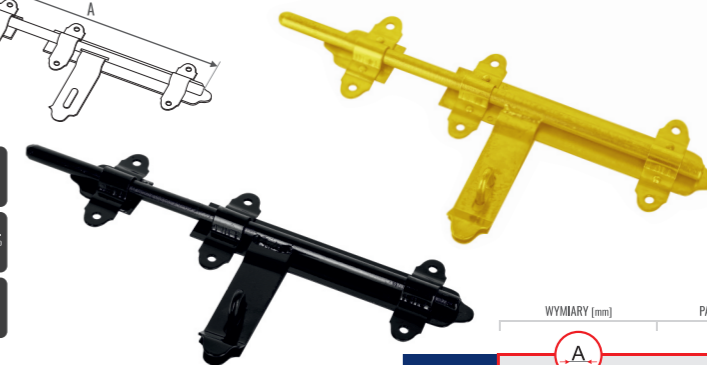
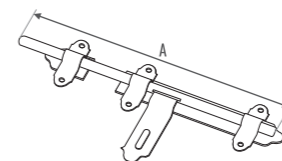

### ZASUWA BRAMOWA

Gate latch  
Pětlice na branu  
Závora branová  
ЗАДВИЖКА ВОРОТНАЯ

	WYMARY (mm)	PAKOWANIE (szt.)	WAGA (g)
ZR450	A	6	1300
ZR450c	450	6	1300

ZPH  
**MARK**  
PROFESJONALNE ŁĄCZNIKI  
DO DREWNA

www.marksc.pl  
biuro@marksc.pl

tel. +48 12 274 69 40

ul. Myśliwska 71  
32-447 Łyczanka

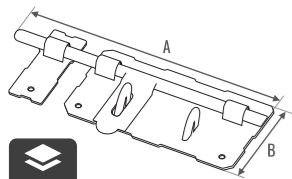

### ZASUWA BRAMOWA SZEROKA

Gate latch wide

Petlice na branu široký

Závora branová široký

ЗАДВИЖКА ВОРОТНАЯ ШИРОКИЙ



	WYMARY (mm)	PAKOWANIE [szt.]	WAGA [g]
ZRBR200c	A: 200, B: 120	6	960

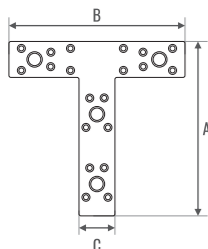

### ŁĄCZNIK PŁASKI TYP "T"

Tee flat fastener

Spojovací plech "T" tvar

Spojka plochá typu "T"

СОЕДИНИТЕЛЬ Т-ОБРАЗНЫЙ

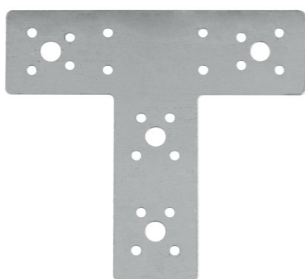

	WYMARY (mm)	GRUBOŚĆ (mm)	OTWORY [szt.]	Ø5	Ø10	PAKOWANIE [szt.]	WAGA [g]
KT158	A: 158, B: 144, C: 45	2.0	4	20	4	10	169

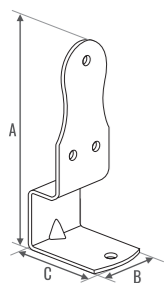

### PODSTAWA SŁUPA PRZYKRĘCANA POŁÓWKA

Screw postfoot half

Polovica nohy stĺpa prikrucane

Patka sloupku polovina

ОСНОВАНИЕ СТОЛБА ПОЛОВИНА



	WYMARY (mm)	GRUBOŚĆ (mm)	Ø10	PAKOWANIE [szt.]	WAGA [g]
PUP1	A: 193, B: 25, C: 65	4.0	4	10	525



### SYSTEM OZDOBNY WKRĘT OGRODOWY Z GŁÓWKĄ TALERZOWĄ

Decorative system garden screw with a washer head

Ozdobny system mark záhradná skrutka s tanierovou hlavou

Ozdobny system mark vrut zahradní s talířovou hlavou

ДЕКОРАТИВНАЯ СИСТЕМА МИРК ШУРУП ДЛЯ САДОВЫХ КОНСТРУКЦИЙ С ТАРЕЛЬЧАТОЙ ГОЛОВКОЙ

	WYMARY (mm)	GRUBOŚĆ (mm)	PAKOWANIE [szt.]	WAGA [g]
SDCT00840	A: 40	8.0	10	135



### SYSTEM OZDOBNY WKRĘT CIESIELSKI Z GŁÓWKĄ STOŻKOWĄ

Woodscrew with a countersunk head

Tesařská skrutka s kuželovou hlavou

Tesařský vrut s kuželovou hlavou

ШУРУП ДЛЯ ДЕРЕВЯННЫХ КОНСТРУКЦИЙ С ПОТЯИНОЙ ГОЛОВКОЙ

	WYMARY (mm)	GRUBOŚĆ (mm)	PAKOWANIE [szt.]	WAGA [g]
SDCS04030	A: 30	4.0	10	38
SDCS45050	A: 50	4.5	10	22

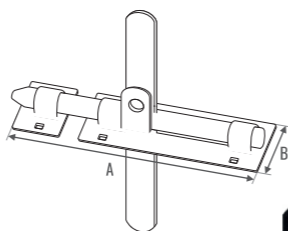

### ZASUWA RYGLOWA DWUSTRONNA

Lock latches

Uzamykanie zastrzece dwojstranne

Posuvný uzávěr oboustranný

ЗАДВИЖКА ВОРОТНАЯ ДВУХСТОРОННИЙ

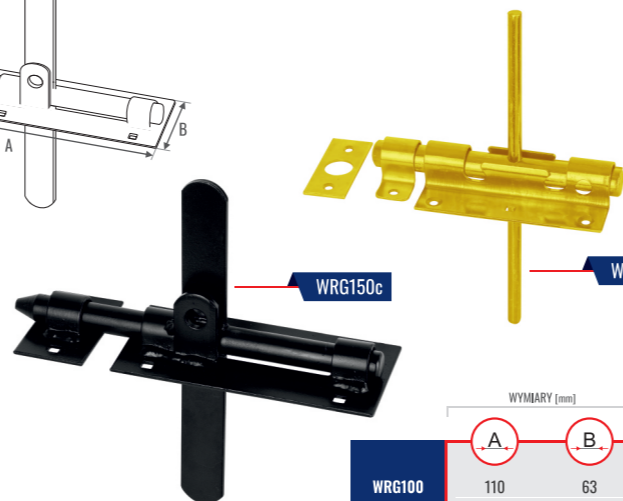

WRG150c

WRG100

	WYMARY (mm)	GRUBOŚĆ (mm)	PAKOWANIE [szt.]	WAGA [g]
WRG100	A: 110, B: 63	1.5	10	444
WRG100c	A: 110, B: 63	1.5	10	444
WRG150	A: 150, B: 70	2.0	10	765
WRG150c	A: 150, B: 70	2.0	10	773

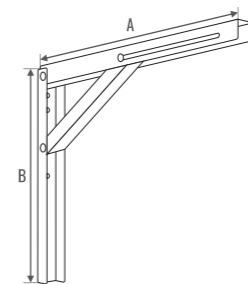

DOSTĘPNE KOLORY:



### WSPORNIK STALOWY SKŁADANY Z BLOKADĄ

Folding steel bracket with lock

Ocelová konzola sklápná so zámkom

Konzola ocelová skládací se zámečkem

КРОНШТЕЙН СТАЛЬНАЯ СКЛАДНОЙ С ЗАМКОМ



	WYMARY (mm)	GRUBOŚĆ (mm)	KOLOR	PAKOWANIE [szt.]	WAGA [g]
WSLB200BI	A: 200, B: 160	1.5	biały	10	327
WSLB200BR	A: 200, B: 160	1.5	brąz	10	327
WSLB200CZ	A: 200, B: 160	1.5	czarny	10	327
WSLB200ST	A: 200, B: 160	1.5	satyna	10	327
WSLB200G	A: 200, B: 160	1.5	galwan	10	327
WSLB300BI	A: 300, B: 260	1.5	biały	10	500
WSLB300BR	A: 300, B: 260	1.5	brąz	10	500
WSLB300CZ	A: 300, B: 260	1.5	czarny	10	500
WSLB300ST	A: 300, B: 260	1.5	satyna	10	500
WSLB300G	A: 300, B: 260	1.5	galwan	10	500
WSLB400BI	A: 390, B: 300	1.5	biały	10	615
WSLB400BR	A: 390, B: 300	1.5	brąz	10	615
WSLB400CZ	A: 390, B: 300	1.5	czarny	10	615
WSLB400ST	A: 390, B: 300	1.5	satyna	10	615
WSLB400G	A: 390, B: 300	1.5	galwan	10	615

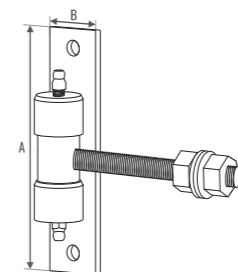

### ZAWIAS REGULOWANY DO PRZYKRĘCANIA DŁUGI

Adjustable hinge for screwing, long

Nastaviteľný pán na skrúťovanie, dlhý

Nastavitelný závěs na šroubování, dlouhý

РЕГУЛИРУЕМАЯ ПЕТЛЯ ДЛЯ ЗАКРУЧИВАНИЯ, ДЛИННАЯ



	WYMARY (mm)	GRUBOŚĆ (mm)	ŚRUBA (mm)	PAKOWANIE [szt.]	WAGA [g]
ZRDW10	A: 130, B: 25	5.0	M10	10	502